

Panasonic

ideas for life

PT-D7700E/E-K

DLP™-Based SXGA+ Projector

The Professional Solution

PT-D7700E-K





3-Chip DLP™-Based System in a Sleek, Compact Body

The World's Lightest 3-Chip Large-Venue DLP™-Based Projector

The PT-D7700E series combines the latest 3-chip system based on DLP™ technology with a new optical system developed using our exclusive technology. We have dramatically reduced the cabinet size, creating a unit with only one-fifth the size of conventional large-venue 3-chip DLP™-based projectors. This feat of design and technology achieved the world's lightest* 3-chip projector with DLP™ technology. With a weight of 22.0 kg (48.5 pounds), the PT-D7700E/E-K can go places other bulky 3-chip projectors with DLP™ technology have never gone before.

* As of July 2004.



Superb Image Quality

Image Quality from 3-Chip DLP™ Technology

DLP™ technology delivers outstanding image resolution. In 3-chip systems with DLP™ technology—considered among the world's most advanced projector engines—a Digital Micromirror Device (DMD) chip is allocated to each of the red, green, and blue signals. This gives systems with DLP™ technology superior light utilisation for high brightness, digital processing for low noise and linear white balance, extended device life for minimal image degradation, and a quick response that eliminates afterimages.

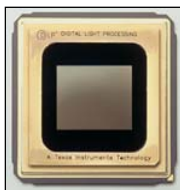

Powerful 7,000 Lumens

In addition to the 300-watt UHM™ lamp, the PT-D7700E series incorporates digital and optical technologies that maximise the DLP™

technology advantages. They deliver 7,000 lumens of brightness, offering superior Colour reproducibility.

Astounding 4,000:1 Contrast Ratio with Dynamic Iris

Panasonic's original Dynamic Iris achieves a dramatically improved contrast ratio of 4,000:1 in the PT-D7700E series. Dynamic Iris constantly monitors the input signal, and adjusts the intensity of the light source to match it. This highly advanced function provides high-speed, linear response to changing images with 256-step precision. It also combines with dynamic gamma control to produce deep, rich blacks while preserving the brightness in the lighter portions of dark scenes. The resulting images are bright and vivid, comparable to direct-view TVs and computer monitors.

16-Bit Colour Depth for Film-Like Natural Image

Applying 16-bit drive to each of the RGB panels produces 8 times the level of expression (a total of 24 times for all three RGB panels) of conventional 13-bit drive devices. This system creates extremely smooth tonal expression with approx. 65,000 shades of gradation.

Progressive Cinema Scan (3/2 Pulldown)

This interlace/progressive conversion technology automatically detects when the input signal is derived from filmed material and selects the optimum progressive processing method to assure faithful reproduction of the original image. It is also compatible with the high-definition 1080i format.

Dynamic Sharpness Control

The Dynamic Sharpness Control circuit adjusts the video signal waveforms based on the difference in the brightness of adjacent pixels for a sharp, clear picture that is relatively unaffected by signal noise.

High Reliability and Easy Maintenance

Liquid-Cooling System

In systems with DLP™ technology, the microscopic mirrors of the DMD chip turn the light on and off. During the off period, light is directed away from the lens. Handling the heat from this light is a major point in maintaining the long-term performance of projec-

tors with DLP™ technology. Panasonic's newly developed liquid-cooling system extends projector performance and attains a high level of reliability.

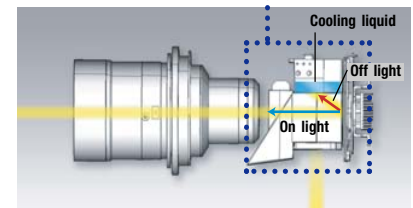

Dustproof Design with Sealed Optical Block

We have minimised the effect of dust by completely sealing the optical block. This dust-free design helps ensure that 3-chip projectors with DLP™ technology will continue to deliver crisp, sharp, high-resolution images over an extended service life.

Dual Lamp System and Lamp Relay Function

The use of two lamp systems increases brightness and eliminates the need to interrupt a presentation if a lamp burns out (in dual lamp operation mode). In single lamp operation mode, the lamp relay function greatly extends continuous operating time.

Optional Long-Life Lamp

A long-life lamp that stretches lamp life to 4,000 hours is available as an option. In single lamp operation mode, the lamp relay function allows non-stop operation 24 hours a day for up to 47 weeks without replacing the lamps. The use of UHM™ lamps dramatically cuts operating costs.

Easy Lamp Replacement

The PT-D7700E series is designed to allow easy lamp replacement with the projector in its fully mounted condition. The lamp itself is the only part that needs to be replaced, which further increases overall reliability.

Dust Filter Cleaning

The dust filter is easy to clean, and you don't have to make any changes in the projector's mounting condition. This helps to minimise user down time.

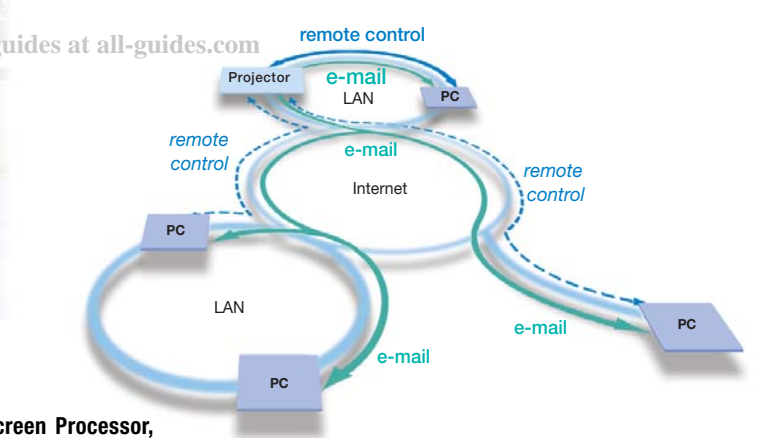

Flexible System Applications

Horizontal/Vertical Lens Shift

The PT-D7700E series is equipped with a motor-driven lens shifting function that moves the lens left, right, up, and down. It gives you easy, accurate adjustment when installing the projector.

Optical Lenses for Various Venues

A wide range of optional lenses with different throw distances are available in addition to the supplied lens. Optional lenses with super-long focal lengths of 8.0 to 15.0 are ideal for use in churches or screening rooms. These powered zoom/focus lenses enable the projectors to perform superbly in an array of projection environments, from classrooms to conference rooms. It's a snap to replace the "click-in" type lenses used in the bayonet system of the PT-D7700E series.

Connection Terminals

The PT-D7700E/E-K feature two RGB inputs, a composite video input and output, and an S-Video input. They also offer RS-232C/422 input and output, two remote inputs, and one remote output.



Connection terminals

An optional board module can be added for more connection flexibility.

Abundant Optional Interface Boards

In addition to the supplied connection terminals, an optional board module can be selected from a total of seven boards to match a variety of input source signals, including digital serial component signals.

Quiet Operation

The PT-D7700E series is designed for quiet operation. A newly developed liquid-cooled optical system and newly designed noise-suppression duct and control system help minimise operating noise. The fan rotation can now be adjusted in finer steps, so fan noise is reduced when rotation adjusts to match room temperature changes. This helps minimise sudden increases in fan noise during operation.

Built-In Multi-Screen Processor, Colour Matching and Edge Blending

MULTI-SCREEN PROCESSOR

The PT-D7700E/E-K can project large, multi-screen images without any additional equipment. Up to 100 units (10 x 10) can be edge-blended at a time.

COLOUR MATCHING

When several units are used together, this function corrects for slight variations in the Colour reproduction range of individual projectors. The PC software assures easy, accurate control. Independent, 7-axis adjustment (red, green, blue, yellow, magenta, cyan, white) ensures high precision and minimises Colour variations. To simplify the set-up process, you can adjust the projectors before delivering them to the presentation site. The Colour-matching function accommodates up to nine units, for multi-screen or single screen presentation.

EDGE BLENDING

This function controls the brightness at overlapping image edges to assure uniform, natural-looking, multi-screen images. When projecting HD sources with a single projector, part of the DMD is unused. In multi-screen projections with two projectors, the DMDs increase the image's horizontal resolution while maximising vertical resolution.

Colour matching Edge blending

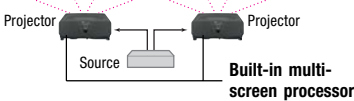
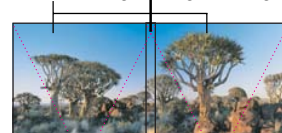

Overlapping image edges



The built-in multi-screen processor enables enlarged multi-screen projection without using any additional special equipment. Colour matching and edge blending make it easier to obtain proper multi-screen picture quality.

Networking (Optional)

Wired LAN System

The optional interface board ET-MD75NT for 10Base-T and 100Base-TX makes the PT-D7700E series network-ready. Simply hook the projector up to an existing LAN network for easy remote control and/or monitoring. System administrators will appreciate this feature when using the PT-D7700E/E-K as a fixed-installation projector.

Web Browser Control/Monitoring

Anybody can operate the PT-D7700E series by remote control or monitor its status over a LAN network, because it is all done using the computer's familiar Web browser.

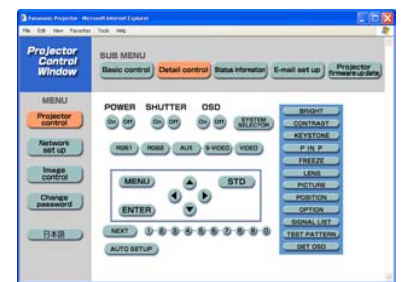

E-Mail Message Alert

The PT-D7700E series automatically sends an e-mail message to notify the operator when an error has occurred, or a lamp needs to be replaced, providing an advanced level of maintenance ease and reliability.

More Valuable Features

- Mechanical shutter completely blocks light leakage when no image is being projected
- Momentary switching for RGB/Video input without disrupting the image
- 96 user memories
- Wireless/wired remote control unit with wireless mouse function*
- ID assignment for up to 64 units
- Coordinated group control for up to 26 groups (A-Z)
- Picture in picture (main/sub input source combinations possible only when using computer and video)
- Digital vertical keystone correction



Wireless/wired remote control

- 3x digital zoom
- Built-in test pattern
- Selectable 9-language on-screen menu (English, German, French, Spanish, Italian, Russian, Japanese, Chinese, Korean)
- Fan control for high elevations (above 1,400 m/4,600 feet)

* Requires the optional ET-RMRC2 wireless mouse receiver



Available in black (PT-D7700E-K) and white (PT-D7700E) cabinet colours.

Ecology-Conscious Design

Panasonic works from every angle to minimise environmental impact in the product design, production and delivery processes, and in the performance of the product itself over its life cycle. The PT-D7700E series reflects the following ecological considerations.

- Lead-free solder is used to mount components to the printed circuit boards.
- Lead-free glass is used for the lens.
- The packing case and operating manual are made from recycled paper.
- Lamp power switching further reduces power consumption.

Options for More Flexible Installation

Lenses



- 1.5-2.0:1 zoom lens ET-D75LE1
- 2.0-3.0:1 zoom lens ET-D75LE2
- 3.0-5.0:1 zoom lens ET-D75LE3
- 5.0-8.0:1 zoom lens ET-D75LE4
- 8.0-15.0:1 zoom lens **Available soon** ET-D75LE8
- 0.8:1 fixed-focus short-throw lens ET-D75LE5

Boards



Network board ET-MD75NT



DVI board ET-MD75DV



SDI (480i/576i) input board ET-MD95SD1



SDI (480i/576i/480p) input board ET-MD95SD2



SDI (720p/1035i/1080i/1080-24p) input board ET-MD95SD3



Analog RGB input board ET-MD95RGB



Video/S-Video input board ET-MD95VM2



Lamps

Replacement lamp unit ET-LAD7500

Replacement lamp units (Twin pack of ET-LAD7500 lamp units) ET-LAD7500W

Replacement long-life lamp unit ET-LAD7700L

Replacement long-life lamp units (Twin pack of ET-LAD7700L lamp units) ET-LAD7700WL

Brackets

Ceiling mount bracket ET-PKD75

Low ceiling mount bracket ET-PKD75S

Dual stacking mount bracket ET-DFD75

Handle

Carrying handle ET-HAD75

Receiver

Wireless mouse receiver ET-RMRC2

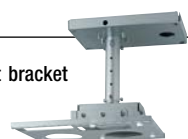

Projection Distance

PT-D7700E/E-K

| Diagonal image size (aspect ratio: 4:3) | Distance to screen | | | | | | | | | | | |
|--|------------------------|----------------|------------------------|-----------------|------------------------|-----------------|------------------------|-----------------|-------------------------|------|-----------------------------|--|
| | ET-D75LE1 1.5-2.0:1 | | ET-D75LE2 2.0-3.0:1 | | ET-D75LE3 3.0-5.0:1 | | ET-D75LE4 5.0-8.0:1 | | ET-D75LE8 8.0-15.0:1 | | ET-D75LE5 0.8:1 fixed | |
| | min. | max. | min. | max. | min. | max. | min. | max. | min. | max. | | |
| 1.8 m / 5.8' (70") | 2.1 m / 6.8' | 2.8 m / 9.0' | 2.8 m / 9.2' | 4.2 m / 13.8' | 4.2 m / 13.9' | 7.1 m / 23.3' | 7.1 m / 23.3' | 11.4 m / 37.3' | | | 1.0 m / 3.4' | |
| 2.5 m / 8.3' (100") | 3.0 m / 9.8' | 4.0 m / 13.1' | 4.0 m / 13.2' | 6.1 m / 19.9' | 6.1 m / 19.9' | 10.2 m / 33.4' | 10.2 m / 33.4' | 16.3 m / 53.4' | Available soon | | 1.5 m / 4.9' | |
| 5.1 m / 16.7' (200") | 6.1 m / 19.9' | 8.1 m / 26.5' | 8.2 m / 26.7' | 12.2 m / 40.1' | 12.3 m / 40.2' | 20.5 m / 67.2' | 20.5 m / 67.3' | 32.7 m / 107.2' | | | 3.1 m / 10.1' | |
| 7.6 m / 25.0' (300") | 9.1 m / 29.9' | 12.2 m / 40.0' | 12.3 m / 40.2' | 18.4 m / 60.4' | 18.4 m / 60.4' | 30.8 m / 101.1' | 30.8 m / 101.1' | 49.1 m / 161.0' | | | 4.7 m / 15.3' | |
| 10.2 m / 33.3' (400") | 12.2 m / 40.0' | 16.3 m / 53.4' | 16.4 m / 53.7' | 24.6 m / 80.6' | 24.6 m / 80.7' | 41.1 m / 134.9' | 41.1 m / 134.9' | 65.5 m / 214.8' | | | - | |
| 15.2 m / 50.0' (600") | 18.3 m / 60.1' | 24.5 m / 80.7' | 24.6 m / 80.7' | 36.9 m / 121.1' | 36.9 m / 121.1' | 61.7 m / 202.5' | 61.7 m / 202.5' | 98.3 m / 322.3' | | | - | |

Projection Range Example

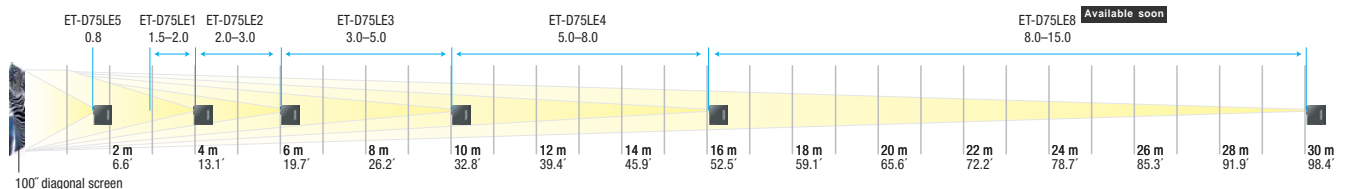

4,000:1 Contrast Ratio

Experience the Difference— Vivid Colours and Richer Blacks

To faithfully reproduce vivid images with both bright and dark areas—the moon in a night sky, penguins in the snow, patterned animals on a grassy plain—you need a projector with high brightness and high contrast. Panasonic's solution: the PT-D7700E series.

Featuring Texas Instruments Digital Light Processing™ and SXGA+ resolution (1,400 x 1,050), the PT-D7700E series delivers outstanding 7,000-lumen brightness and 4,000:1 contrast.*

A number of breakthrough Panasonic technologies make this performance possible. Our Dynamic Iris, for example, improves contrast by precisely matching the lamp output to the input signal. Working together with our liquid-cooled optical engine, the Dynamic Iris helps produce images with astonishing definition. The PT-D7700E series also incorporates improvements in reliability and durability. Allowing extended-time operation, these models let you enjoy the superior image quality provided by DLP™ technology in a wide range of operating environments.

With superior brightness, image quality, reliability and extended-time usability, PT-D7700E models meet a host of applications in auditoriums, conference rooms, control centres and other facilities.

* With the Dynamic Iris set to 3.



Dynamic Iris: Deeper Blacks, Brighter Whites, and Vivid, True-to-Life Colour

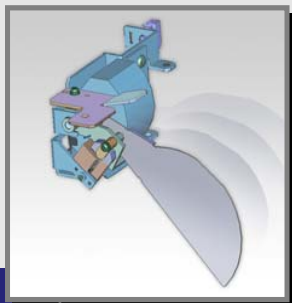

Incorporating Panasonic exclusive technology, the Dynamic Iris opens and closes with exceptional speed and precision as the input signal changes, resulting in accurate, real-time control of the light striking the DMD chips. The Dynamic Iris is posi-

tioned immediately after the light synthesiser and before the integrator, so it has minimal adverse effect on the overall light uniformity across the screen.



Competitor A
Blacks and other dark portions are washed out.

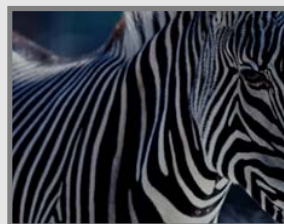

Competitor B
Thanks to functions such as lamp power switching, the blacks are not washed out. The white portions, however, become dim and dull.



Dynamic Iris and Dynamic Gamma
Dynamic Iris quickly fine-tunes the lamp output with 256-step precision. Dynamic Gamma preserves the brightness in bright portions, helping maintain a wide dynamic range.

Specifications

| | |
|-------------------------------------|---|
| System | DLP™ system |
| Device | 0.95" (diagonal) DMD™ (x 3), 4:3 |
| Pixels | 1,470,000 (1,400 x 1,050) x 3 |
| Lamp | 300 W UHM™ lamp x 2 (BriteOptic™ Dual Lamp System) |
| Brightness | 7000 lumens (dual lamp) 3500 lumens (single lamp) |
| Contrast ratio | 4000:1 (full white/full black, with dynamic iris set to "3") |
| Resolution | |
| RGB | 1400 x 1050 pixels |
| Video | 560 TV lines |
| Lens | Optional |
| Screen size | 70"–600" diagonal |
| Lens shift | Vertical, horizontal |
| RGB input scanning frequency | f _H 15–100 kHz, f _V 24–120 Hz, Dot clock 20–162 MHz |
| Component signal | 480i, 576i, 480p, 576p, 720/60p, 1035/60i, 1080/60i, 1080/50i, 1080/25p, 1080/24p, 1080/24sF, 1080/30p |
| Video signal | NTSC, PAL, SECAM, M-NTSC, PAL60, PAL-M, PAL-N |
| Terminals | |
| VIDEO IN | BNC |
| VIDEO OUT | BNC |
| S-Video IN | Mini DIN 4-pin |
| RGB1/YPbPr IN | BNC x 5 |
| RGB2 IN | D-sub HD 15-pin |
| Optional board slot | x 1 |
| RS-232C/422 IN | D-sub 9-pin female |
| RS-232C/422 OUT | D-sub 9-pin male |
| REMOTE 1 IN | M3 jack |
| REMOTE 1 OUT | M3 jack |
| REMOTE 2 IN | D-sub 9-pin female (parallel) |
| Optical axis shift* | Powered; horizontal ±30%, vertical ±50% |
| Keystone correction range | ±40° (with ET-D75LE2) |
| Installation | Front/rear, ceiling/floor, (menu selection) |
| Power cord length | 2.5 m (8.2') |
| Power supply | 220–240 V AC, 50/60 Hz |
| Power consumption | 800 W (800 VA) (15 W during stand-by mode with fan stopped) |
| Dimensions (W x H x D) | 530 x 200 x 540 mm (20-7/8" x 7-7/8" x 21-9/32") (without lens and lens hood) |
| Weight | 22.0 kg/48.5 lbs (without lens) |
| Operating temperature | 0°–40°C (32°–104°F) 0°–35°C (32°–95°F) (dual lamp, lamp power: high) |
| Operating humidity | 10%–80% (no condensation) |

Optional accessories

- Replacement lamp unit (single): ET-LAD7700
- Replacement lamp unit (set of two lamps): ET-LAD7700W
- Replacement long-life lamp unit (single): ET-LAD7700L
- Replacement long-life lamp unit (set of two lamps): ET-LAD7700WL
- Ceiling mount bracket: ET-PKD75
- Low ceiling mount bracket: ET-PKD75S
- Dual stacking mount bracket: ET-DFD75
- Carrying handle: ET-HAD75
- Zoom lens (1.5–2.0:1): ET-D75LE1
- Zoom lens (2.0–3.0:1): ET-D75LE2
- Zoom lens (3.0–5.0:1): ET-D75LE3
- Zoom lens (5.0–8.0:1): ET-D75LE4
- Zoom lens (8.0–15.0:1): ET-D75LE8 (Available soon)
- Fixed focus lens (0.8:1): ET-D75LE5
- DVI board: ET-MD75DV
- Network board: ET-MD75NT
- Video/S-Video input board: ET-MD95VM2
- SDI (480i/576i) input board: ET-MD95SD1
- SDI (480i/576i/480p) input board: ET-MD95SD2
- SDI (720p/1035i/1080i/1080-24p) input board: ET-MD95SD3
- RGB/YPbPr input board: ET-MD95RGB
- Wireless mouse receiver: ET-RMRC2

Lamp mode/brightness

| No. of lamp | Lamp power | Brightness | |
|-------------|------------|-------------|----------------|
| | | Normal lamp | Long-life lamp |
| Dual | High | 7,000 lm | – |
| | Low | 5,600 lm | 3,500 lm |
| Single | High | 3,500 lm | – |
| | Low | 2,800 lm | 1,750 lm |

Lamp mode/lamp life

| Lamp mode | Brightness | |
|-----------|-------------|----------------|
| | Normal lamp | Long-life lamp |
| High | 1,500 hr | – |
| Low | 2,000 hr | 4,000 hr |

- Using the long-life lamps, lamp life is 8,000 hours maximum when operated in single lamp mode with the lamp relay function on.
- Lamp life varies depending on usage conditions and the surrounding environment.
- When the long-life lamps are used the lamp power mode is automatically set to low.

Dimensions

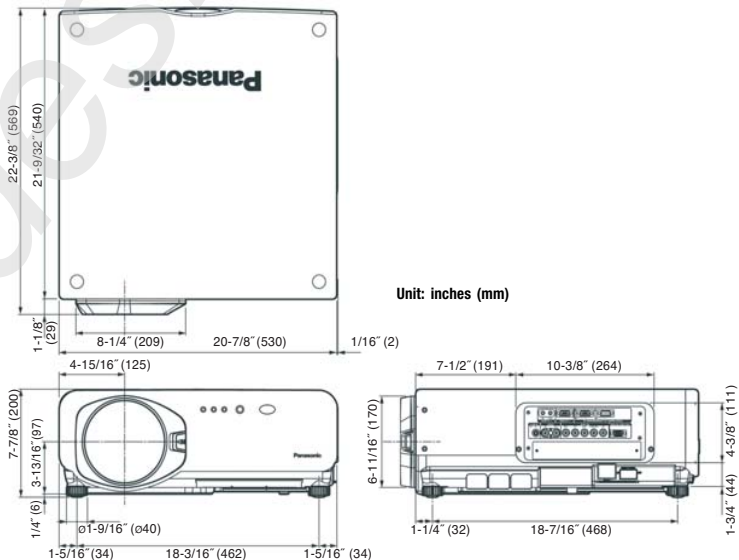

Unit: inches (mm)

NOTES ON USE

- The projector uses a high-voltage mercury lamp that contains high internal pressure. This lamp may break, emitting a large sound, or fail to illuminate, due to impact or extended use. The length of time that it takes for the lamp to break or fail to illuminate varies greatly depending on individual lamp characteristics and usage conditions.
- The brightness of the lamp will gradually decrease with use.
- The replacement cycle of the lamp will be shortened if the power is frequently turned on and off or the projector is subjected to daily continuous use for 10 or more hours.



Weights and dimensions shown are approximate. Specifications are subject to change without notice. Product availability differs depending on region and country. This product may be subject to export control regulations. UHM is a trademark of Matsushita Electric Industrial Co., Ltd. Digital Light Processing, DLP, DLP logo and the DLP medallion are trademarks of Texas Instruments. VGA and XGA are trademarks of International Business Machines Corporation. All other trademarks are the property of their respective trademark owners. Projection images simulated.

